

PLAN

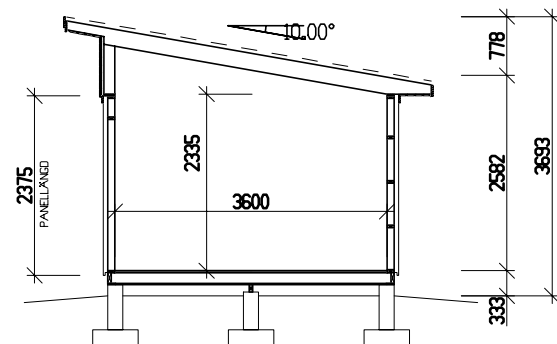

SEKTION

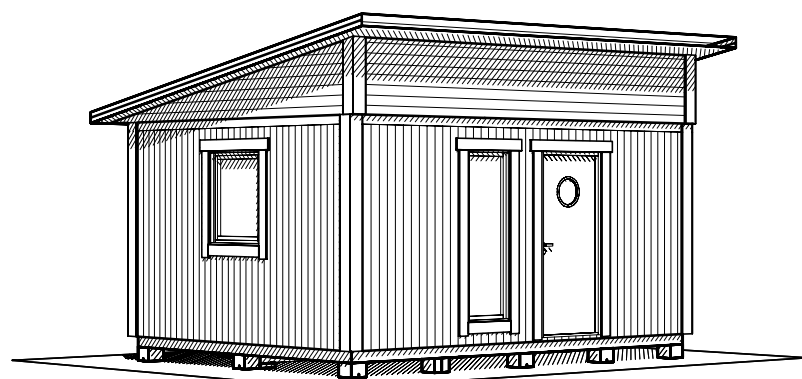

PERSPEKTIV

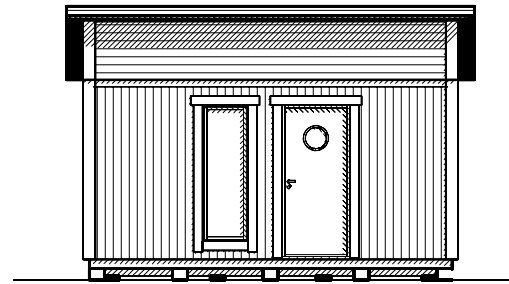
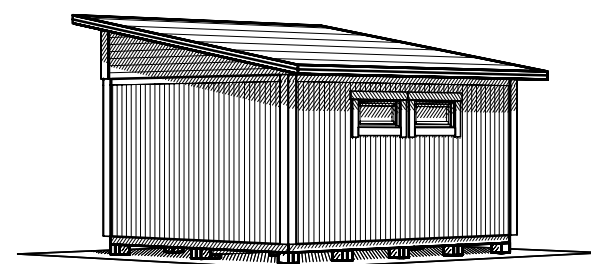

FASAD MOT

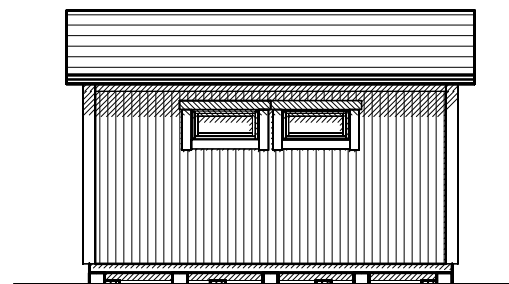

FASAD MOT

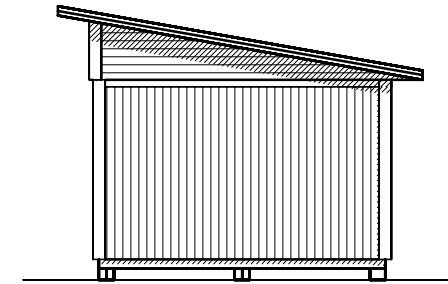

FASAD MOT

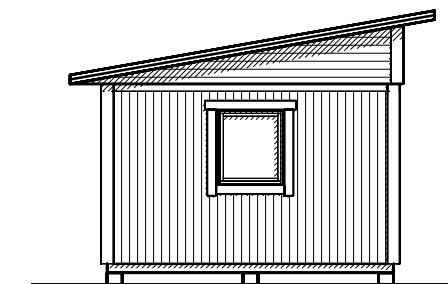

FASAD MOT

PANEL: FUNKISPANEL 22x120.  
 STOMME: 34x95.  
 OISLERAT.  
 BJÄKLÄG 45x145.  
 GRUNDLÄGGNING: PLINT GRUND.  
 LEVERANSOMFATTNING ENLIGT AVTAL.

BET	ANT	ÄNDRINGEN AVSER	DATUM	SIGN
-----	-----	-----------------	-------	------

BYGGLOVSHANDLING  
 NYBYGGNAD AV KOMPLEMENTBYGGNAD



UPPDRAG NR/RITN. NR XXXX	RITAD/KONSTR AV PH
DATUM 2018-11-02	HANDLÄGGARE

PLAN & SEKTION  
 NJUTA FUNKIS 20-1

ANSVARIG

SKALA  
 1:100, A3

NUMMER  
 A01

BET